

2024 CATALOG



TABLE OF CONTENT

01 Acrylic guards 2

03 Cases & accessories 4

05 Dispensers 7

07 Flag stands 9

09 L-stands 13

11 Panel displays 19

13 Poster stands 23

15 Roll up stands 28

17 Table top stands 32

19 Tents 34

21 X-stands 40

02 Black board 3

04 Conventional stands 6

06 Face covers 8

08 Literature racks 12

10 Outdoor stands 14

12 Poster frames 20

14 Promotion tables 27

16 Standoffs 31

18 Table throws 34

20 Trade show displays 35

22 Yard signs 42

2024 PRODUCT
CATALOG

ACRYLIC GUARDS

- › Model#: ASG-PS series
- › 5mm thick main panel
- › 10mm thick base
- › Free-standing
- › Easy to wipe clean and sanitize
- › Available sizes: 24"x36", 36"x30" & 36"x48"



BLACK BOARDS

- > Model#: TBB100
- > Board size: 22" x 31"
- > Double sided
- > Mahogany-finished aluminum frame
- > Can be written on with both chalk and erasable marker



- > Model#: TBB500
- > Board size: 23" x 36"
- > Double sided
- > Solid pine wood frame
- > Anti-slip rubber feet
- > Can be written on with both chalk and erasable marker
- > Replaceable chalkboard

CASES & ACCESSORIES

- > Model#: CGH1 & CHG2
- > 4" & 4.25" diameter
- > Extends up to 50" long
- > Made out of PVC



- > Model#: CGH55
- > 5" diameter
- > Extends up to 50" long
- > Made out of PVC



- > Model#: CGH series
- > Made out of aluminum and MDF
- > Foam cushion inside
- > Available in different sizes



- > Model#: CGH-D series
- > Includes shoulder strap
- > Hard canvas bag
- > Available in different sizes



- > Model#: CGH-R96-BLK
- > PVC hard case with built-in wheels
- > Fits most banner stands, pop up displays, etc.
- > Nylon web straps and buckle to secure lid to close
- > Available in black color only



CASES & ACCESSORIES

- > Model#: CGH-RS-1A
- > PVC hard case
- > Includes shoulder strap
- > Fits our standard roll up stand up to 39" wide



- > Model#: CL1 / CL2
- > Halogen or LED
- > For pop up displays



- > Model#: CL4 / CL5
- > Halogen or LED
- > For banner stands

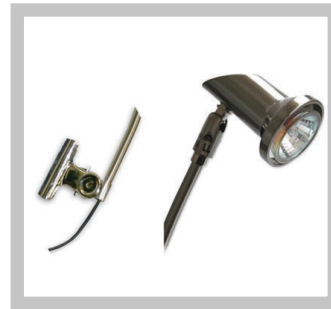

- > Erasable florescent markers
- > Available in dry or wet erase

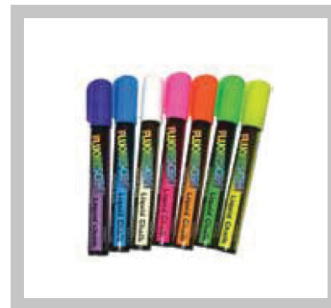

- > High strength self-adhesive hook and loop
- > Easy peel backing liner
- > 100% Nylon material
- > Simply peel and stick to a clean surface
- > Available in Black color only
- > 1" wide



CONVENTIONAL STANDS

Adjustable Banner Stands

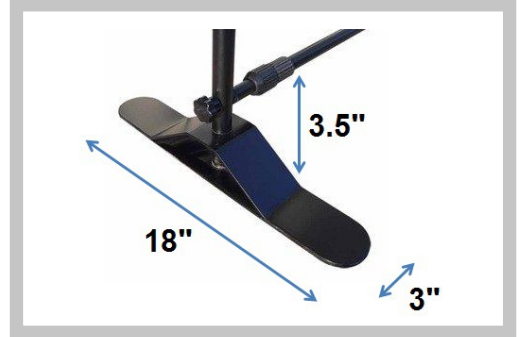

- > Model#: CPH300 series
- > Available sizes: 48" x 36" to 96" x 96" & 64" x 36" to 120" x 96"
- > Telescopic steel poles
- > Adjustable width and height
- > Easy to assemble
- > Comes with a canvas carryingbag

DISPENSERS

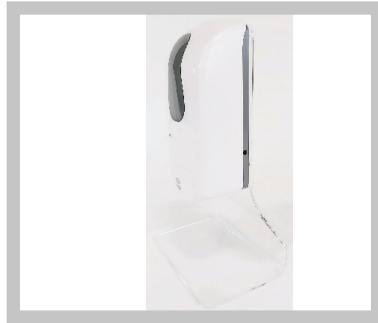

- > Model#: CTD-1L
- > Fully automatic gel-type dispenser
- > Table top or wall mount
- > Free-standing stand also available
- > 1-liter capacity removable tank
- > Battery operated (battery excluded)
- > Adjustable flow mount level
- > Secured with a key
- > Made out of strong ABS plastic
- > Indoor use only

FACE COVERS



- > Model#: Face Mask
- > 2-layer flat or 3D face mask
- > 3-layer 3D with filter also available
- > Heat transferred dye-sublimation print
- > Breathable polyester fabric
- > Individually wrapped
- > One size fits most

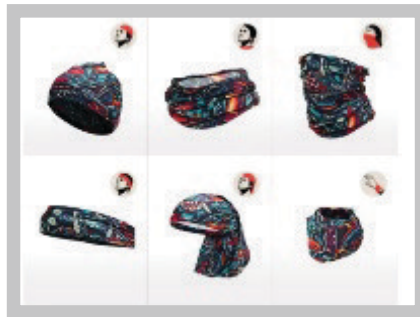

- > Model#: Bandana
- > Breathable spandex fabric
- > Sewn edges
- > Heat transferred dye-sublimation print
- > One size fits most
- > Washable



FLAG STANDS



- > Model#: CFS200
- > Available size: approximately 7ft high
- > High quality super durable fiberglass pole
- > Variety of base options
- > Unique design to turn in the wind
- > Suitable for both indoor and outdoor
- > Poles come with a canvas carrying bag
- > We also offer a complete package including printing and finishing

Tear Drop, Feather & Rectangular Flag Stands



- > Model#: CFS100 series
- > Available size: approximately 7ft, 11ft & 16ft
- > High quality super durable fiberglass pole
- > Variety of base options
- > Poles come with a canvas carrying bag
- > Suitable for both indoor and outdoor
- > We also offer a complete package including printing and finishing



FLAG STANDS

P-Shape Flag Stands



- Model#: CFS400 series
- Available size: approximately 8ft & 12ft high
- High quality super durable fiberglass pole
- Variety of base options
- Suitable for both indoor and outdoor
- Poles come with a canvas carrying bag
- We also offer a complete package including printing and finishing

FLAG STANDS

Pole Banner Hardware



- > Model#: CFS-SB series
- > Single or side-by-side
- > Installs to light or street poles
- > Fits 24" wide banner
- > Heat-treated cast aluminum
- > 24" fibreglass cross arm pole
- > Mounting hardware included

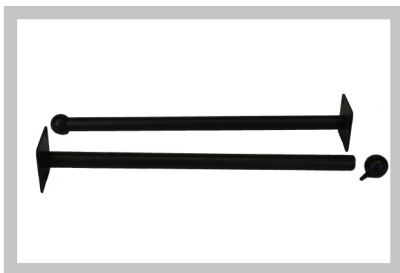

- > Model#: CFS-WM-24
- > Fits 24" wide banner
- > Black powder coated steel
- > Wall mount
- > Removable knob



LITERATURE RACKS



- > Model#: CLR200
- > Collapsible magazine rack
- > 6-pocket
- > Made out of aluminum and acrylic
- > Heights 56.5" when set up
- > Fits 8.5" x 11" literature
- > Comes with a canvas bag or an aluminum case



- > Model#: CLR400B
- > 8-pocket mesh literature rack
- > Made out of aluminum frame and fiberglass pole
- > Heights 53.5" when set up
- > Each pocket measures 9.5" x 12"
- > Comes with a canvas bag

L-STANDS

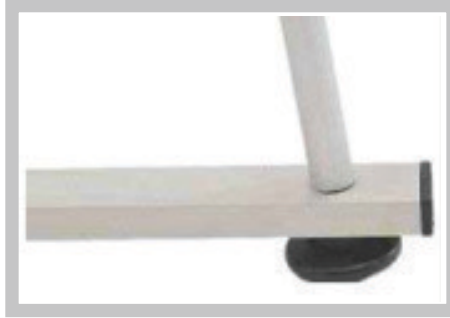

- › Model#: CLS300 series
- › Graphic sizes: 23.5" x 64", 31.5" x 72", 35.5" x 80"
- › Aluminum construction
- › Foldable banner stand
- › Clamp bars
- › Comes with a canvas carrying bag

OUTDOOR STANDS

Metal A-frames



- > Model#: COS100 series
- > Made out of 2cm x 2cm steel tube
- > Fits two sheets of coroplast or sintra
- > Rubber coated handle for extra comfort
- > Weather resistant power coated paint
- > Superior quality metal A frame
- > Available sizes: 18" x 24", 24" x 18", 22" x 28"
24" x 32", 24" x 36", 24" x 28", 32" x 48" & 36" x 48"
- > White color available in 24" x 36"

OUTDOOR STANDS

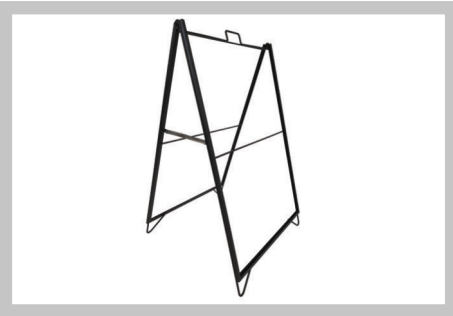

- Model#: COS-ECO100-2436
- Powder coated steel construction
- Fits 2 standard 24" x 36" coroplast posters
- Channels to slide in the posters
- Top loading
- Fully assembled and ready to use
- Flat packed and individually boxed
- Ideal for both indoor and outdoor use

OUTDOOR STANDS



- > Model#: COS-P2332-GREY
- > Constructed from HDPE (high density polyethylene)
- > Fits two 23" x 32" posters
- > Channels to slide in the posters
- > Top loading
- > Fully assembled and ready to use
- > Can be filled with water or sand
- > Flat packed & individually boxed
- > Ideal for both indoor and outdoor use

Sign Holders



- > Model#: COS200A
- > Made out of PVC
- > Holds up to 36" x 48" substrate
- > Can be filled with water or sand
- > Easy to assemble
- > Suitable for both indoor and outdoor use
- > Individual units can be joined together

OUTDOOR STANDS



- > Model#: COS400A
- > Graphic size: 24" x 34"
- > Double-sided aluminum snap poster frame
- > Clear overlay for graphic protection
- > Can be filled with water or sand
- > Easy to assemble
- > Suitable for both indoor and outdoor use



- > Model#: COS410 series
- > Available size: 24" x 36" & 24" x 48"
- > Fits 2 substrates, such as coroplast
- > Plastic tank base or "H" base
- > The plastic tank can be filled with water or sand
- > Easy to assemble
- > Suitable for both indoor and outdoor use

OUTDOOR STANDS

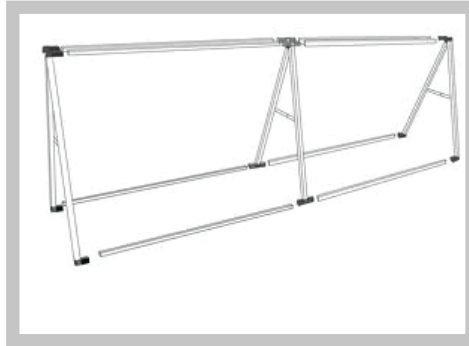

- > Model#: COS700-820
- > Graphic size: 80" x 33"
- > Light weight aluminum frame
- > Can be used single-sided or double-sided
- > Can be used as a graphic barrier for events
- > Bungee cords and ground peg included
- > Comes with a canvas carrying bag



- > Model#: COS800
- > Light weight aluminum frame
- > Can be used single-sided or double -sided
- > Plastic hollow bases for water or sand weighting
- > Individual units can be joined together

PANEL DISPLAYS



- > Model#: CPF8
- > 8-panel board
- > Double-sided fabric on each board
- > Optional small top boards
- > Each panel size: 23.5" x 35.5"
- > Fabric area: 21.25" x 33.25"
- > Top panel size: 23.5" x 8"
- > Black aluminum frame
- > Can turn 360 degrees
- > Comes with a canvas carrying bag

POSTER FRAMES

Aluminum Snap Frames



- › Model#: CPF100 series
- › 2.5cm slim aluminum profile
- › Mitered corner
- › Clear overlay for graphic protection
- › Silver anodized finish
- › Includes screws and drywall plastic anchors
- › PVC backing panel
- › Available size: 8.5"x11", 11"x17", 22"x28", 24"x30" & 24"x36"

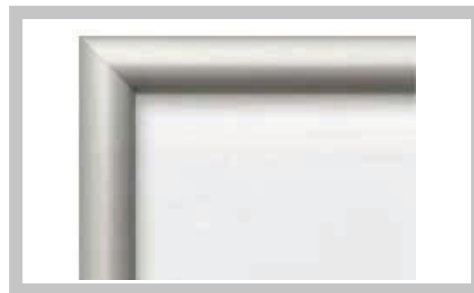
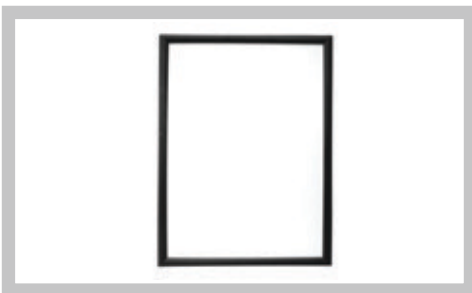

- › Model#: CPF200 series
- › 2.5cm slim aluminum profile
- › Mitered corner
- › Clear overlay for graphic protection
- › Silver anodized finish
- › Black color available in 8.5"x11"x 11"x17", 18"x24" & 24"x36"
- › Includes screws and drywall plastic anchors
- › PVC backing panel
- › Available size: 8.5"x11", 11"x17", 18"x24", 22"x28", 24"x30", 24"x36", 30"x40", 30"x48" & 36"x48"

POSTER FRAMES

Aluminum Poster Rails



- > Model#: CPR1 series
- > Available size: 2ft, 3ft, 4ft, 5ft & 6ft
- > Custom sizes are also available up to 6ft
- > Clamp aluminum bar
- > Slide-in hooks
- > PVC end caps

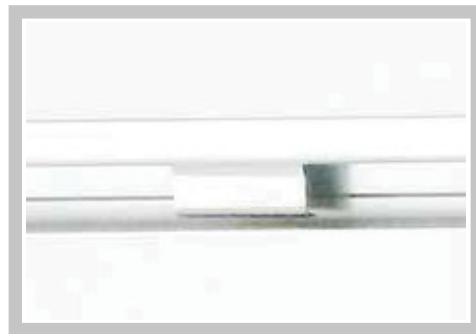

- > Model#: CPR3 series
- > Available sizes: 2ft, 3ft & 4ft
- > Holds up to 5mm coroplast or sintra
- > Slide-in hooks
- > Plastic end caps

POSTER FRAMES

PVC Poster Rails



- > Model#: CPR2 series
- > Available sizes: 2ft, 3ft, 4ft, 5ft & 6ft
- > Custom sizes are also available up to 6ft
- > Clamp PVC bar
- > Slide-in hooks

POSTER STANDS



- Model#: CPS100A series
- Available sizes: 11" x 17" & 22" x 28"
- Snap aluminum poster frame with stand
- Adjustable height
- Clear overlay for graphic protection

Aluminum Sandwich Boards



- Model#: CPS200-1
- Graphic size: 24" x 34"
- Snap aluminum poster frame
- 3.2cm aluminum profile
- Double-sided
- Clear overlay for graphic protection
- Indoor use only

Easel Stands



- Model#: CPS400
- Holds up to 48" x 33" signs
- Aluminum easel stand
- Adjustable height
- Comes with a carrying bag

POSTER STANDS



- > Model#: CPS500 series
- > Available sizes: 12", 24", 36" & 48"
- > Made out of steel
- > Includes nuts and bolts
- > Holds up to 1/2" rigid board



- > Model#: CPS600-1117
- > Poster size: 11" x 17"
- > Double-sided
- > Black powder coated steel
- > Quick assembly
- > 1/4" deep top-insert slot
- > Fits one 5mm coroplast sheet

POSTER STANDS



- > Model#: CPS-RS-228-N
- > Poster size: 22" x 28"
- > Double-sided
- > Black powder coated steel
- > 3/8" deep top-insert slot
- > Fits 5mm coroplast
- > Indoor use only

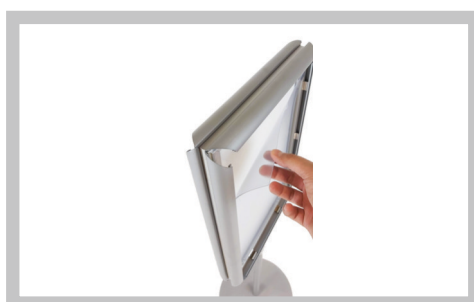

- > Model#: CPS700-1117-D
- > Graphic size: 11" x 17"
- > Free standing double sided snap poster frame
- > Clear overlay for graphic protection
- > Silver anodize finish
- > Made out of aluminum
- > Indoor use only

POSTER STANDS



- > Model#: CPS-HS-8511-BLK
- > Black powder coated
- > Holds 3.25" diameter bottle
- > 8.5" x 11" snap frame
- > Height adjustable
- > 14" diameter round steel base
- > Indoor use only

PROMOTION TABLES

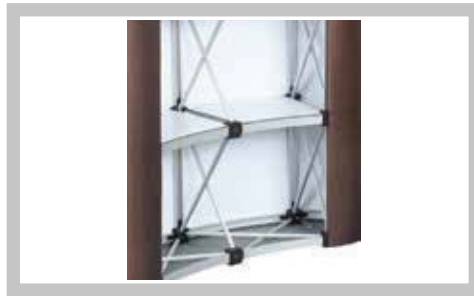

- > Model#: CPT300
- > Size: approximately 50" x 16" x 35"
- > Light weight yet strong and sturdy
- > Aluminum pop up frame
- > Black countertop
- > Can be easily dismantled for storage
- > Comes with a canvas carrying bag

ROLL UP STANDS

Standard Roll Up Stands

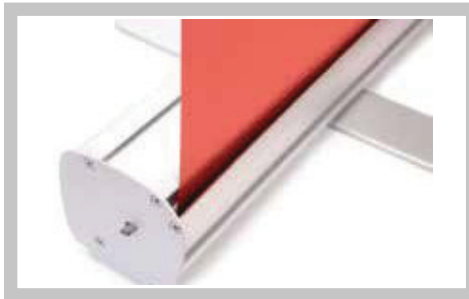

- > Model#: CRS100 series
- > Available sizes: 23.5"x77", 28"x77", 33"x77", 36"x77", 39"x77" & 47"x77"
- > Inter-locking 3-in-1 pole
- > Clamp aluminum top bar
- > Comes with a padded carrying bag
- > Aluminum cartridge roll
- > 1-year limited warranty
- > Black color available in 33"x77"

Standard Double-sided Roll Up Stands



- > Model#: CRS200A
- > Double-sided retractable banner stand
- > Graphic visual size: 33"x77"
- > Clamp aluminum top bar
- > Comes with a padded carrying bag
- > Aluminum cartridge roll
- > 1-year limited warranty

ROLL UP STANDS

Adjustable Roll Up Stands

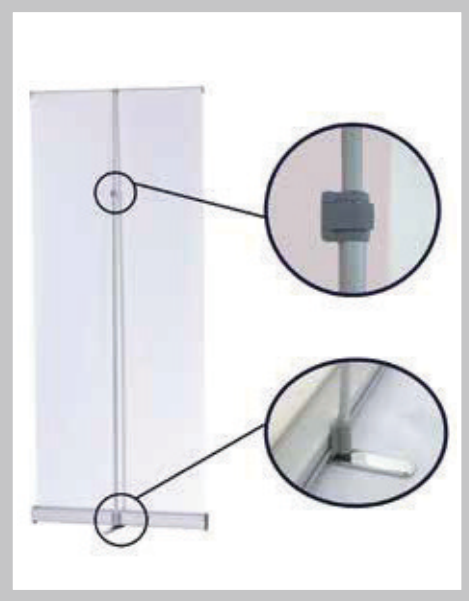

- > Model#: CRS300A
- > Graphic visual size: 33" wide x 62" to 87" high
- > Aluminum telescopic pole
- > Clamp aluminum top bar
- > Comes with a padded carrying bag
- > 1-year limited warranty

Deluxe Roll Up Stands



- > Model#: CRS400A
- > Graphic visual size: 33" wide x 39" to 94" high
- > Aluminum telescopic pole
- > Clamp aluminum top bar
- > Replaceable aluminum cartridge
- > Comes with a padded carrying bag
- > Adjustable feet for uneven surfaces
- > 1-year limited warranty

ROLL UP STANDS

Premium Roll Up Stands

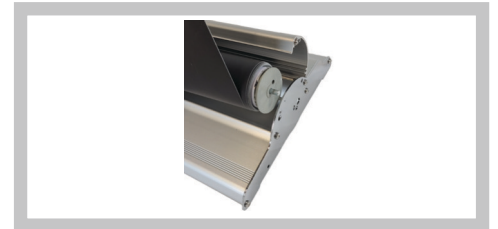

- > Model#: CRS510 series
- > Available sizes: 24"x79", 33"x79", 36"x79", 39"x79" & 48"x79"
- > Inter-locking 3-in-1 pole
- > Clamp aluminum top bar
- > Replaceable aluminum cartridge
- > Chrome end caps included
- > Comes with a padded carrying bag
- > Adjustable feet for uneven surfaces
- > Black color available in 33"x79"
- > 1-year limited warranty



- > Model#: CRS700-60
- > Graphic visual size: 59" x 79.5"
- > Black powder coated
- > Inter-locking 3-in-1 pole
- > High quality aluminum
- > Clamp aluminum top bar
- > Adjustable feet for uneven surfaces
- > Comes with a canvas carrying bag
- > 1-year limited warranty

STANDOFFS

- > Satin finished aluminum standoff
- > Available sizes: 1.3cmx1.9cm, 1.6cmx2.5cm, 1.9cmx2.5cm, 1.9cmx3.5cm, 2.5cmx2.5cm, 2.5cmx3.5cm, 3cmx2.5cm & 3cmx3.5cm



- > Chrome finished aluminum standoffs
- > Available sizes: 1.3cmx1.9cm, 1.6cmx2.5cm, 1.9cmx2.5cm, 1.9cmx3.5cm, 2.5cmx2.5cm, 2.5cmx3.5cm, 3cmx2.5cm & 3cmx3.5cm



- > Available sizes: 1.3cmx1.9cm, 1.6cmx2.5cm, 1.9cmx2.5cm & 2.5cmx2.5cm



- > Chrome finished edge grip standoffs
- > Available size: 1.9cmx2.5cm
- > Made out of aluminum



- > Chrome finished corner grip standoffs
- > Available size: 2.5cmx2.5cm
- > Made out of aluminum



TABLETOP STANDS



- > Model#: CRS600B-D
- > Double-sided
- > Graphic visual size: 11.75"x16.5"
- > Lightweight yet stable
- > Aluminum table top roll up stand



- > Model#: CXS500
- > Graphic size: 11"x17"
- > Lightweight yet stable
- > Made out of PVC



- > Model#: CPS300 series
- > Available length: 8.25"x11.75", 24" & 36"
- > Lightweight yet stable
- > Fits 4mm substrate, such as coroplast
- > Made out of aluminum
- > Also available in Black color



- > Model#: CLS500B
- > Graphic size: 11.75"x16.75"
- > Lightweight yet stable
- > Made out of aluminum

TABLETOP STANDS



- > Model#: CRS-TT series
- > Graphic visual size: 12"x18" and 18"x24"
- > Aluminum table top roll up stand
- > Clamp aluminum top bar
- > Dark grey plastic end caps
- > Comes with a carrying bag

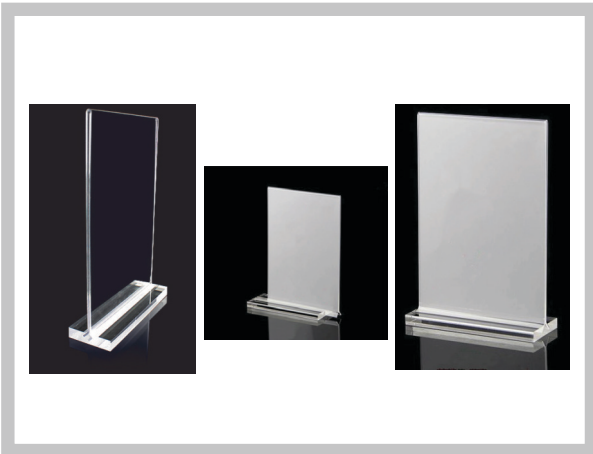

- > Model#: CAD-TT series
- > Available sizes: 8.5"x11" & 11"x17"
- > Table top acrylic sign frame
- > Posters slide in from the sides
- > Viewable from both sides

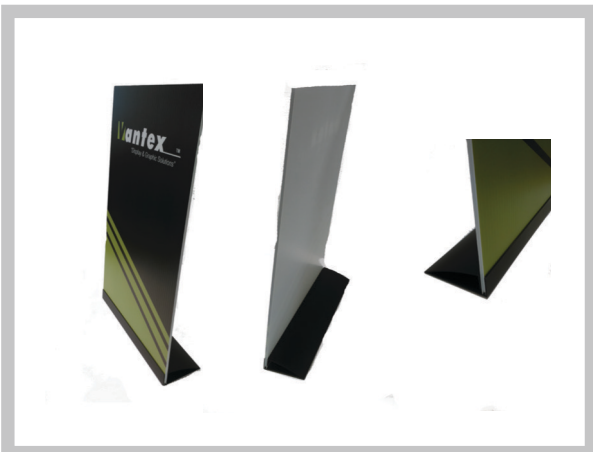

- > Model#: CPS-TT series
- > Available length: 8.5", 11" & 24"
- > Table top aluminum poster holder
- > Black powder coated
- > Fits 4mm substrate, such as coroplast
- > Made out of aluminum

TABLE THROWS



- For standard 4ft, 6ft & 8ft tables
- Custom sizes available
- We offer standard full size, standard open back, fitted full size, fitted open back, stretch, stretch open back and corner pleated table throws
- 100% polyester fabric (fire retardant fabric also available on some models)
- Full color dye sublimation printing
- Table runners also available

TENTS



- Model#: CCT series
- Available sizes: 5ftx5ft, 6.5ftx6.5ft, 10ftx10ft, 10ftx15ft & 10ftx20ft
- Heavy duty commercial grade corrosion resistant and fully anodized 1.57" diameter hexagon aluminum frames
- Pull pin slider for quick lock and release
- 500D polyester fire retardant (CAN/ULC-S 109-4)
- Back walls and side walls are optional
- Full color dye sublimation printing
- Comes with a roller bag for the frame
- Optional iron weights, water fill-able weights, sand bags, gutters, multi-tent connectors, ground pegs and flag pole holder kits are also available

TRADE SHOW DISPLAYS

Tension Fabric Pop Up Displays

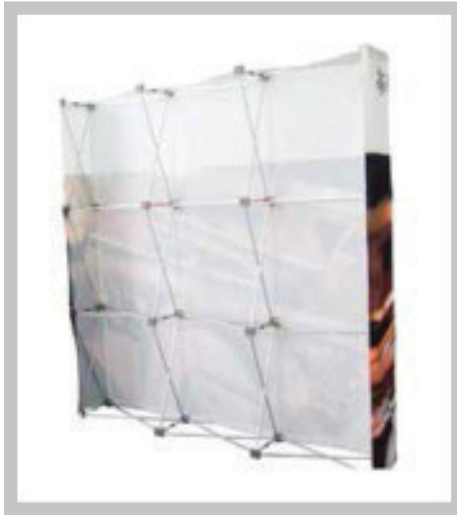
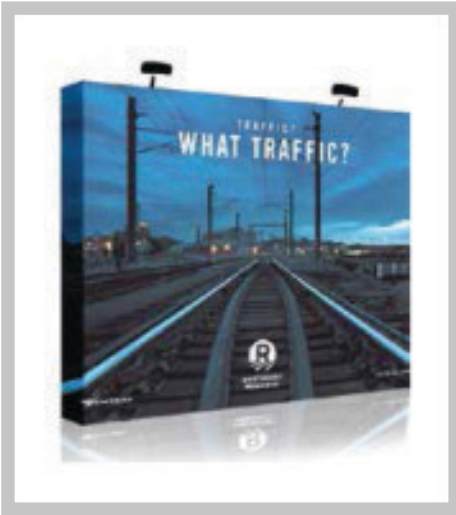

- Model#: CPD200 series
- Available sizes: 90" x 90" & 119.25" x 90"
- Quick assembly within 10 minutes
- Matte finished aluminum frames
- Seamless stretch fabric
- Comes with 2 halogen lights and a hard case
- Lightweight yet stable
- 10-year limited warranty on frames
- 5ft table top version also available
- Our fabric meets CAN/ULC S109-24 & NPFA 701 standards for fire safety

TRADE SHOW DISPLAYS

Hanging Display Systems

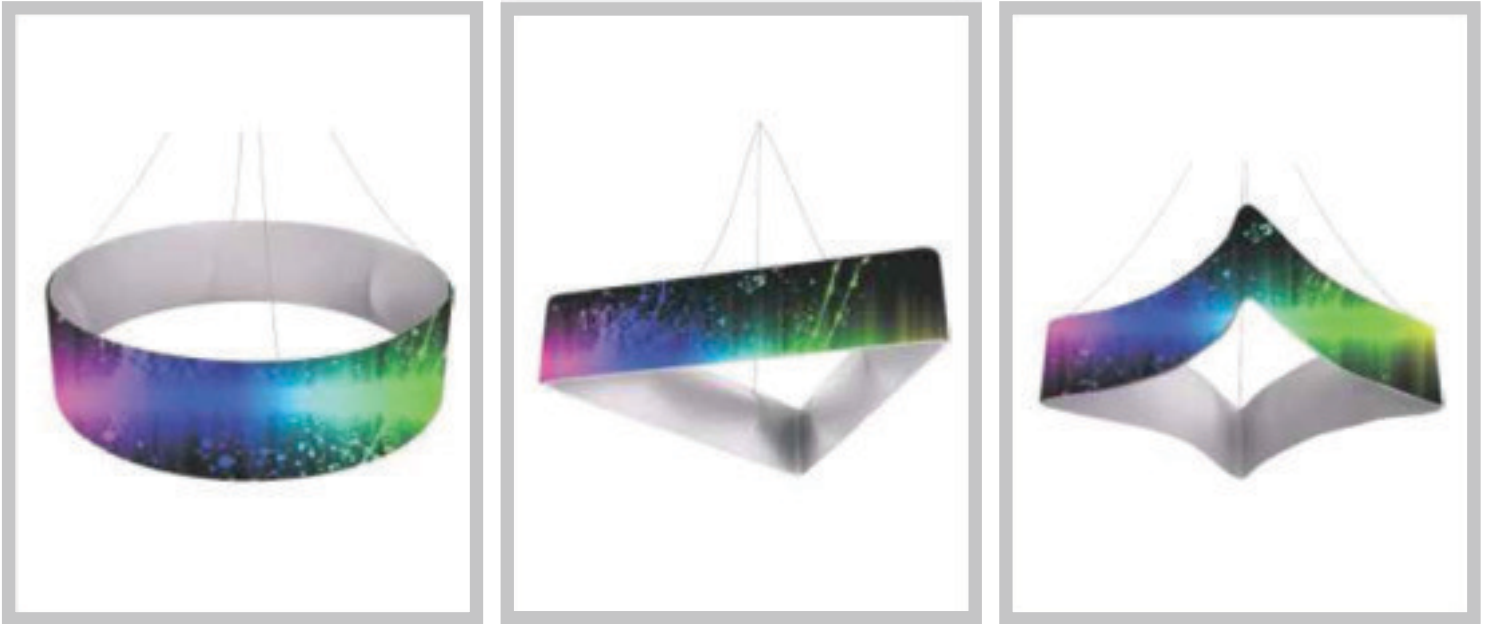

- › Model#: CHD series
- › Different shapes and sizes available
- › Design to suspend from ceilings to create high visual impact
- › Can be suspended one within another
- › Lightweight framework that clicks together effortlessly
- › Aluminum tube frames that are durable
- › Seamless pillow case mounting stretch fabric with industrial zipper
- › High quality full color dye sublimation printed fabric
- › No tools required to set up
- › 5-year limited warranty of frames
- › Frames come with a carrying bag
- › Our fabric meets CAN/ULC S109-24 & NPFA 701 standards for fire safety

TRADE SHOW DISPLAYS

Premium Pop Up Displays

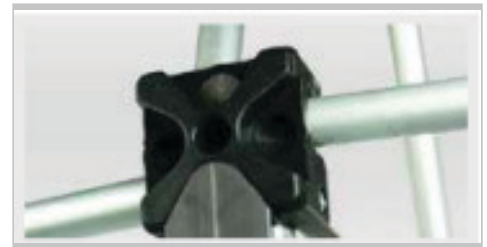
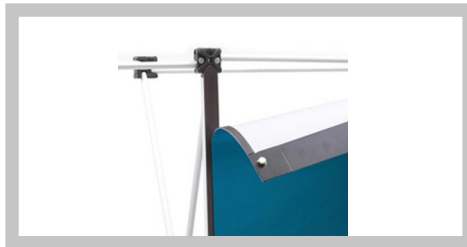

- > Model#: CPD100 series
- > Available sizes: 8ft x 8ft & 10ft x 8ft
- > Self-licking matte finished aluminum frames
- > Quick assembly
- > Magnetic channel bars
- > Lightweight yet stable
- > 10-year limited warranty of frames
- > Comes with 2 halogen lights and a podium hard case

Tension Fabric Systems

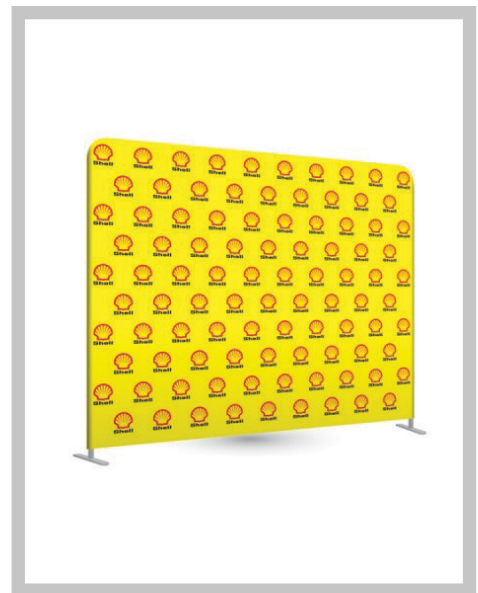

- > Model#: CTF series
- > Available in curve, straight & S shape
- > Available in many different sizes
- > 1.25" snap aluminum tube frames attached with a bungee cord for ease of assembly
- > Comes with a carrying bag
- > Seamless pillow case style mounting stretch fabric with industrial zipper
- > 5-year limited warranty of frames
- > Lights and cases are optional
- > 6ft and 8ft table top version also available
- > Our fabric meets CAN/ULC S109-14 & NFPA 701 standards for fire safety

TRADE SHOW DISPLAYS

Geometric-shaped Pop Up Displays

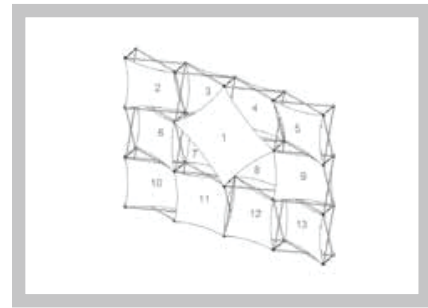

- > Model#: CPD300 series
- > Available sizes: 87" x 87" & 115.5" x 87"
- > Self-locking aluminum frames
- > 10-year limited warranty of frames
- > Stretch polyester fabric prints
- > Multiple looks within one display
- > Comes with 2 halogen lights and a hard case

Rubber-edge Tension Fabric Displays

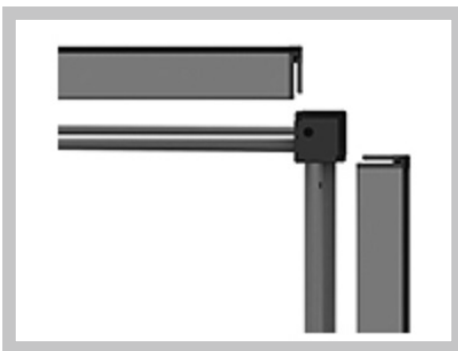

- > Model#: CPD-SEG series
- > Available sizes: 87.5" x 87.5" & 116" x 87.5"
- > Self-locking aluminum frames
- > Quick assembly
- > Seamless stretch fabric
- > Rubber edge fabric
- > Bordless exhibition structure
- > 10-year limited warranty of frames
- > Comes with 2 halogen lights and a hard case

TRADE SHOW DISPLAYS

Tabletop Tension Fabric Displays

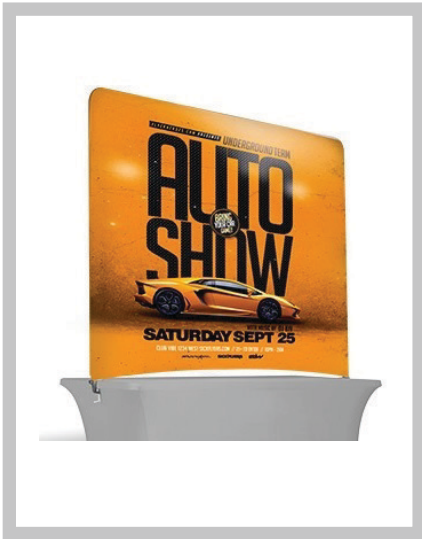

- › Model#: CTF-TT series
- › Available for standard 6ft and 8ft tables
- › 1" diameter interlocking black powder coated aluminum poles
- › Seamless pillowcase style fabric
- › Comes with a carrying bag
- › 5-year limited warranty on frames

LED Backlit Tension Fabric Displays

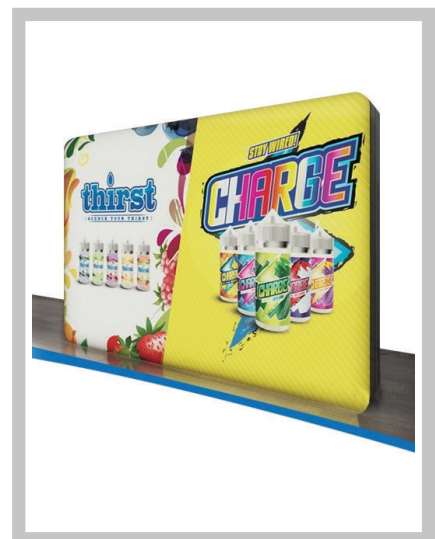

- › Model#: CTF-LB-STR series
- › Available sizes: 4ft, 8ft, 10ft & 20ft wide
- › Standard height: 89"
- › 12V LEDs
- › Seamless pillowcase style fabric
- › Interlocking aluminum poles
- › Comes with a carrying bag
- › 5-year limited warranty on frames

X-STANDS

Standard X-stands



- > Model#: CXS200 series
- > Graphic sizes: 24" x 64", 28" x 72" & 34" x 76"
- > Fiberglass pole and metal construction
- > Foldable banner stand
- > Designer for a banner with grommets in each corner
- > Comes with a carrying bag

Economy X-stands

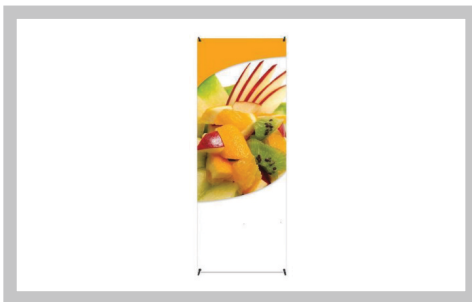

- > Model#: CXS300 series
- > Graphic sizes: 24" x 64" & 28" x 72"
- > Complete fiberglass pole construction
- > Foldable banner stand
- > Designer for a banner with grommets in each corner
- > Comes with a carrying bag

X-STANDS

Bamboo X-stands



- > Model#: CXS-BB series
- > Graphic sizes: 24" x 64" & 24" x 72"
- > Made out of Bamboo
- > Foldable banner stand
- > Designer for a banner with grommets in each corner
- > Comes with a carrying bag

YARD SIGNS

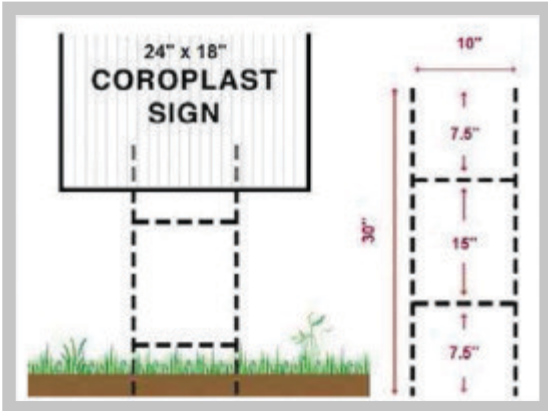

- > Model#: H10-30
- > H-wire step stakes
- > Available size: 10" x 30"
- > 9 guage galvanized wire

2024 PRODUCT CATALOG